

X12 Operation Manual

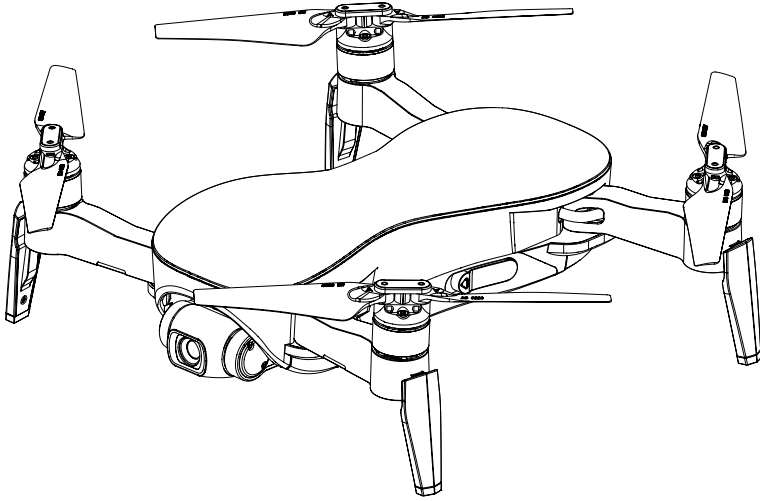

Google Play



APP Store

Important

- *For your safety and to avoid loss of property, please read this manual carefully.*
- *Please do not disassemble, modify or repair the aircraft. If necessary, please contact the agent.*
- *This manual is concise. For more details, please go to the "Help" in the upper right corner of the APP main interface and download the electronic documents, or visit www.jjrc.com for more instructions and tutorials.*

Content

I. Important notes -----	1	VIII. Fly with the remote controller -----	16
1. Flight safety -----	1	1. Power on -----	16
2. Flight environment -----	1	2. Connect with the APP -----	16
3. GPS mode and flight mode -----	2	3. Operate the aircraft -----	17
4. RTH (Return to home) -----	2	4. Photo and video -----	19
5. Low battery RTH -----	2	5. Adjustment of the camera's pitch angle -----	20
6. Control loss RTH -----	2	6. Flight mode -----	20
7. Compass calibration -----	2	7. Return to home -----	21
II. Instructions for lithium battery usage -----	5	8. Remove the battery and store it separately -----	21
1. Usage -----	5	9. Pair aircraft and RC -----	21
2. Charging -----	5	IX. Flying with the APP -----	22
3. Storage and transportation -----	6	1. Power on -----	22
4. Disposal -----	6	2. Connect with the APP -----	22
5. Maintenance -----	6	3. Initiate aircraft -----	22
6. Attention for boarding -----	6	4. Photo and video -----	24
III. Disclaimers and warnings -----	7	5. Adjustment of the camera's pitch angle -----	25
IV. Technical support -----	7	6. Flight mode -----	25
V. Newbie mode -----	7	7. Return to home -----	27
VI. Know X12 -----	8	8. Waypoint flying -----	28
1. Aircraft -----	8	X. MV filming -----	29
2. Remote controller -----	9		
3. About optical flow positioning system -----	10		
4. Download APP -----	11		
VII. Preparation before flight -----	12		
1. Battery charging for aircraft -----	12		
2. Remote controller preparation -----	13		
3. Preparing the drone -----	14		
4. Insert TF card -----	14		
5. Battery installation -----	15		

I. Important notes

1. Flight safety

- (1) This aircraft is not a toy. It is applicable for users of 14 years of age and above.
- (2) Please familiarize with the local laws, regulations and flying environment before flying. Stay away from sensitive places, and only fly where it's legal to fly a drone.
- (3) Please make sure that the aircraft flies within your sight. DO NOT fly the aircraft around the obstacles, otherwise it might lead to accidents.
- (4) Please make sure you have the remote controller and the mobile device in your hand so that the aircraft can be controlled at any time in case of accidents!
- (5) Please keep away from the drone when it is in motion.
- (6) Please turn off the aircraft and remote controller immediately when it completes flying.
- (7) Please strictly comply with the safety rules when using the lithium battery. Never leave the battery unattended while charging to avoid any accidents.
- (8) DO NOT fly the drone or use any type of remote controller within a radius of 500 meters of an airport. DO NOT use the remote controller when and where the radio restrictions might apply.

2. Flight environment

- (1) Choose an open area, far away from people, animals, buildings, trees, high-voltage cables and other obstacles etc.



- (2) Do not fly in bad weather, such as windy, rainy, snowy and foggy weather etc.



- (3) Stay away from tall buildings, high-voltage cables, communication base stations and WiFi hotspots, which will severely affect the signal receiving of the aircraft, resulting in flight accidents caused by abnormal flight data.

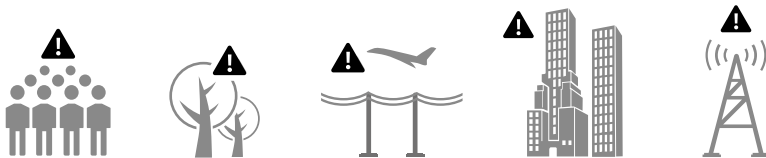

- (4) Do not contact the propeller in motion, otherwise it may cause serious injury. Safety is the priority for both you and your surrounding environment and people. Therefore please familiarize with the no-fly zone and the safety instructions before flight. Please enter the APP to download and read the disclaimer.



3. GPS mode and flight mode

The aircraft has built-in GPS positioning module, which will be used to position locations in autonomous flight. Follow the steps herein and the aircraft will enter GPS Positioning Mode:

- (1) The remote controller is in P (Position Hold) Mode.
- (2) The GPS DOP is at a proper rate for accurate positioning.

At this time, the aircraft can hover and fly autonomously.

If any of two conditions is missing, the aircraft would automatically enter the altitude hold mode. However, due to the interference effect of the wind force, the aircraft might drift while hovering and the functions are not able to use at all.

Notice:Autonomous flight refers to flights that are controlled by internal programming that tells where it is positioned and where to fly, rather than a person sending radio signals, including,RTH, one key return,way point flight and point of interest, etc.

4. RTH (Return to home)

When the aircraft enters the GPS positioning mode, the built-in GPS can automatically record its takeoff point as home point. In the following circumstances, the aircraft will automatically initiate RTH:

Notice:When the aircraft initiates auto return to home, users can only control the function when it has returned and starts to land.

- (1) When the battery level is low, the aircraft would automatically initiate RTH.
- (2) When the aircraft is disconnected with the remote controller, the aircraft would automatically initiate RTH.

In the RTH mode,if the aircraft flies under 30 meters, it will automatically ascend to the altitude of 30 meters before returning to the home point and landing. If it flies over 30 meters, it will directly return to the home point and then land on the ground.

During the flight, ensure that the aircraft flies within the line of sight, and do not fly around the obstacles (such as buildings, trees, etc.). Obstacles might block signals, which will lead to the disconnection between the aircraft and the remote controller, thus triggering the aircraft to enter the RTH mode. This may cause the aircraft to hit an obstacle in the course of RTH and cause accidents.

5. Low battery RTH

- (1) Low battery RTH

During the flight, when the battery level is low, the status indicator light of the aircraft would turn slowly blinking red with a prompt message from the APP as well. At this point, the aircraft automatically initiates the RTH mode.

Once the low battery RTH mode is enabled, you can only change the landing site but not turn it off.

- (2) Critical low battery warning

When the battery level is at a critical low condition, the status indicator light of aircraft would turn quickly blinking red and the aircraft would immediately land on the ground.

6. Control loss RTH

- (1) Control loss RTH with GPS positioning

In the GPS positioning mode,if the signal of the remote controller has been interrupted, the aircraft will hover at the current altitude for 5 seconds. If the signal has not been reconnected, the aircraft would automatically enter RTH mode.

- (2) Control loss RTH without GPS positioning

When the aircraft fails to locate the position and the signal of the remote controller has been interrupted for 2 seconds, the aircraft would automatically land.

7. Compass calibration

Notice:When changing the flight site, it is necessary to calibrate the compass before the first flight. During usage , if the aircraft indicates with "alternating flashing blue and green lights", which means that

the compass is abnormal , please re-calibrate the compass.

Please keep away from the environment with magnetic interference when calibrating, otherwise it may cause calibration failure.

The built-in compass helps keep the aircraft oriented.Please ensure it works well every time before flight.

○ Please calibrate the aircraft compass, if one of the following scenarios happen:

- (1) Fly at the new flight site;
- (2) The aircraft status indicator light indicates the abnormal situation of the compass;
- (3) APP and aircraft prompt you to calibrate the compass;
- (4) Hovering or drifting in mid-flight.

○ Calibrate the compass via the APP:

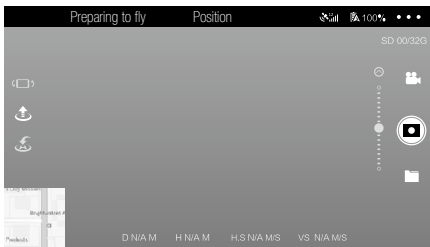

(1) Enter the calibration mode

When the aircraft and APP are connected, click the "...icon in the upper right corner of the APP control interface to enter the "General Setting" menu.

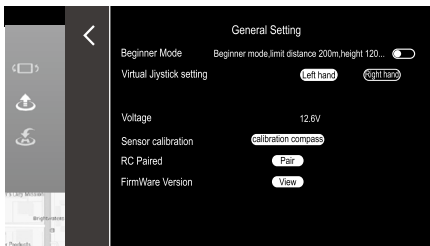

Then click the "compass calibration" icon.

When APP pops up the prompt, check the current environment and stay away from metal objects. then click the "calibration" icon.

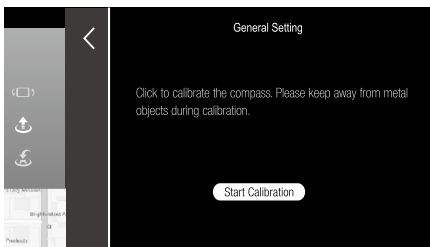

Meanwhile,the status indicator light on the aircraft's rear arm will turn blue and red lights flashing alternately, indicating that it has been ready for calibration.

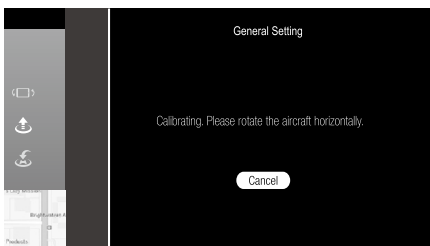

X12 Operation Manual

(2) Compass calibration

Step 1: Horizontal calibration

When the APP prompts you to rotate the aircraft horizontally, put the aircraft in your hand horizontally and then rotate it horizontally until the status indicator light on the arm of the aircraft turns red and green light flashing alternately (i.e., the horizontal calibration is successful).

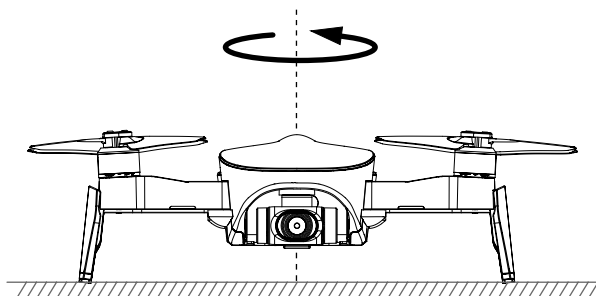

Step 2: Vertical calibration

When APP prompts you to rotate the aircraft with its nose facing up, hold the aircraft in your hand with its nose facing up. Place the aircraft on the ground and then rotate it horizontally.

The compass has been calibrated successfully when the status indicator light on the aircraft's rear arm turns green (solid or flashing).

When the APP prompts you with "calibration is successful", click "Complete" to complete calibration.

If the status indicator light turns red (about 6 seconds), which means compass calibration fails, please change the position and re-calibrate.

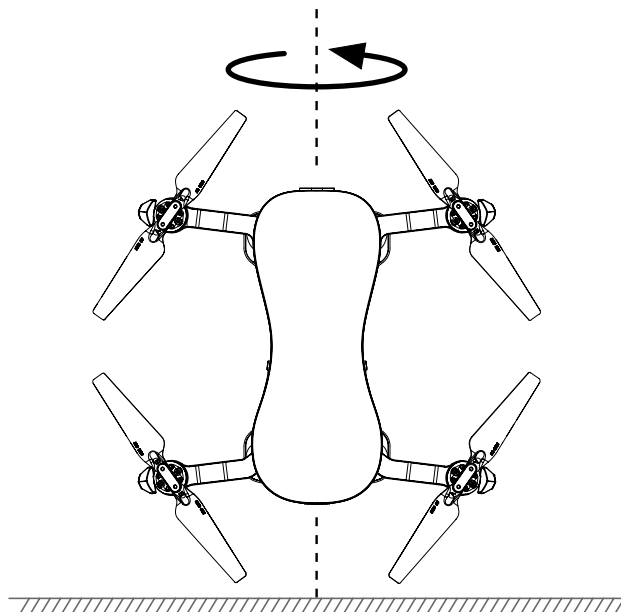
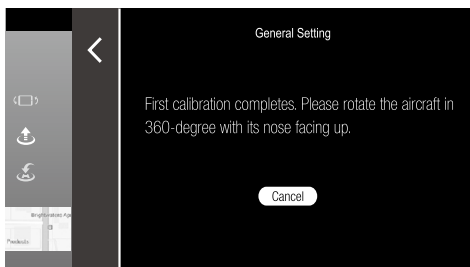

II. Instructions for lithium battery usage

Warning: Read the entire user manual and familiarize with the functions of the product before proceeding. If the product is not properly operated, it may cause serious injury, or lead to product damage and property loss.

This product requires sophisticated pilots with experienced operation. Without a strong sense of safety, improper operation may lead to damage and property loss, or even serious injury.

This product is not suitable for children. Do not use components that are not provided or recommended by us. Please strictly comply with the instructions for product installation and usage. This user manual includes safety, operation and maintenance instructions.

Please read through the instructions and warning tips carefully before assembling, setting up and using the product. Improper usage, charging or battery storage may cause fire, property loss or personal injury. It is important to refer to the following instructions for battery usage.

1. Usage

- (1) No battery is allowed to be exposed to any liquid. Do not immerse the battery in water or get it wet. Never use batteries in rain or damp environment. Soaked with water may lead to decomposition, self-ignition, or even explosion.
- (2) Do not use non-specified batteries. For replacement, please contact the local retailer for additional information. Using non-specified batteries may lead to product damage or flight failures, or even cause accidents.
- (3) It is strictly prohibited to use batteries that are swollen, leaky, or worn. If any of the above occurs, please contact the sales agent or local retailer for further processing.
- (4) Do not hit the battery. Do not place objects over batteries or chargers.
- (5) The battery should be used between ambient temperature of 0 to 40 degrees Celsius. When the temperature is too high (above 50 degrees Celsius), the battery will catch fire or even explode. Low temperature (below 0 degrees Celsius) might lead to a decrease of the battery lifespan.
- (6) It is forbidden to use batteries in strong static or magnetic fields. Otherwise, the battery protection board might not work, resulting in malfunction of the aircraft.
- (7) It is forbidden to disassemble the battery or pierce it with sharp objects. Otherwise, it might cause battery ignition or explosion.
- (8) The liquid inside the battery is highly corrosive. If there is any leakage, keep away from the battery. If the liquid inside the battery splashes onto human skin or eyes, please rinse it out immediately with clean water for at least 15 minutes and seek medical treatment immediately.
- (9) If the battery drops or is hit by external force, it must not be used anymore.
- (10) If the battery accidentally falls into the water during the flight or under other circumstances, pull out the battery immediately and place it in a safe open area. At this time, keep away from the battery until the battery is completely dry. Do not use the battery, and dispose it properly. If the battery catches on fire, use solid materials to put out the fire, such as sand, blanket, dry powder and carbon dioxide fire extinguishers.
- (11) Do not place batteries in a microwave oven or pressure cooker.
- (12) Do not place battery cell over the conductor.
- (13) No wires or other metal objects are allowed in case of short circuits.
- (14) If there is dirt on the battery interface, clean it up with a piece of dry cloth. Otherwise, it might cause contact failure, resulting in energy loss or charging failure.

2. Charging

- (1) The battery must be charged with the specific charger. Charging with a non-specific charger might cause product damage and

even accidents. We will not bear the responsibility for consequences resulting from improper charging.

- (2) When charging, please place the battery and charger on the non-flammable and combustible ground (such as cement ground). Please pay attention to the charging process to avoid accidents.
- (3) It is forbidden to charge the battery immediately when the flight completes, with that the battery is not cooled down yet and charging might lead to a decrease of the battery lifespan. Charge the battery when its temperature approaches to the room temperature. The ideal charging temperature (5 C-40 C) can greatly extend the battery lifespan.
- (4) After charging, please disconnect the charger from the battery immediately. Regularly check and maintain the charger. Do not use damaged charger.

3. Storage and transportation

- (1) Please store batteries in places where children can't reach. If children accidentally swallow some parts of the product, please immediately seek for medical help.
- (2) It is forbidden to place batteries in direct sunlight or near heat sources, such as cars, fires or heaters. The ideal storage temperature is 22 C~28 C.
- (3) Store the battery in dry environment. Do not place batteries in water or where there is water leakage.
- (4) Do not impact, crush or puncture batteries. Do not drop or short circuit the battery.
- (5) Do not store or transport batteries with spectacles, watches, metal necklaces, hairpins or other metal objects.
- (6) Do not transport worn batteries. If necessary, discharge the battery until 30% battery level remains before transport.
- (7) If not in use for more than 10 days, please store the battery with 40%~65% battery level remaining, which can extend its lifespan.
- (8) Do not completely discharge the battery if not intended to use it for a long time, as to avoid over-discharging, which will ultimately disable the battery.

4. Disposal

- (1) The battery must be completely discharged before being placed in the recycling bin. Batteries are dangerous chemicals. It is strictly prohibited to dispose the battery in regular garbage bins. Please follow the local laws and regulations for battery disposal.
- (2) Over-charging batteries are unable to use. Please dispose them.

5. Maintenance

- (1) Do not use charger when the temperature is too high or too low.
- (2) Do not store batteries when the room temperature reaches above 60 degrees Celsius.
- (3) Do not overload the battery, otherwise it might cause damage to the cell.
- (4) If the battery is idle for a long time, its performance will be affected.
- (5) Recharge and discharge once every 3 months to maintain battery activity.

6. Attention for boarding

- (1) Before bringing the battery to the airplane, please discharge the battery until 5% battery level remains.
- (2) Please store the battery in a ventilated and dry place.

III. Disclaimers and warnings

This product is not a toy! In the process of using, please adhere to the safety rules. This product is not suitable for children under 14 years of age. Do not expose children to this product. Be careful when using this product in places within children's reach.

For novice pilots, please have an experienced pilot to be supervised for the flight.

Be sure to read this manual carefully before using the product and familiarize with individual rights and responsibilities and related safety instructions. Otherwise, it may bring about property loss, safety accident and personal injury. Once this product is used, it is deemed that you have understood, approved and accepted all the terms and conditions of this statement. Users promise to be responsible for all their consequences and their actions. The user shall undertake the responsibility of using the product for legitimate purposes and agree with this clause and any relevant policies or guidelines that we may formulate.

IV. Technical support

We guarantee that all products are strictly inspected and tested before coming into the market. Any new information or technology, we will update on the official website.

Users can contact the local distributor to seek for technical support or purchase additional spare parts.

V. Newbie mode

For novice pilot, please turn on the newbie mode. Once the newbie mode is activated, the aircraft will locate its own position before ready to take off. If the aircraft can not be controlled after take-off, the RTH can be used to allow the aircraft to return automatically.

VI. Know X12

Equipped with a two-axis self-stabilizing gimbal and HD camera, X12 is a smart flying camera with multiple flight modes.

X12 features with functions such as way point flying, follow me, return to home, point of interest, one key take-off and landing, etc. It is equipped with a camera that can adjust the pitch angle, so that you can get a unique perspective and composition, and take unique photos and videos.

It gives up to 25 minutes of flight time.

1. Aircraft

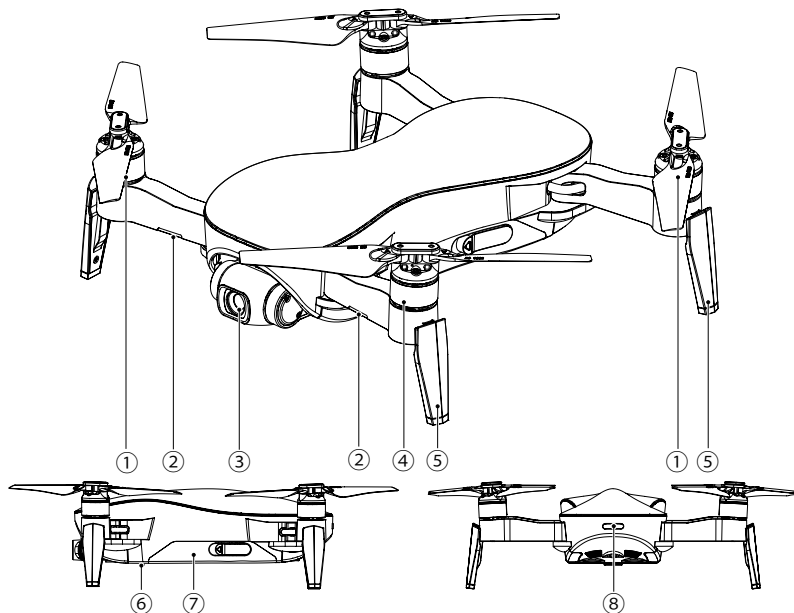

1) About the aircraft





- ① CCW Motor/Propeller
- ② Head /Optical Flow Status Indicator Light
- ③ Gimbal/Camera
- ④ CW Motor/Propeller
- ⑤ Landing Gear
- ⑥ TF Slot
- ⑦ Aircraft Battery
- ⑧ Flight Status Indicator Light

2) Aircraft indicator light

Observe the indicator light to keep track of the status of the aircraft. Please refer to the following instructions of different indicator lights.

○ Optical flow status indicator(Front arm indicator)

Indicator Light		Status Indication
	Solid blue light on start-up	Self-inspection
	Solid green light	RC and aircraft is paired,GPS is located
	Flashing green light	RC and aircraft is paired,GPS is not located
	Blue and red light flashing alternately	Horizontal calibration process
	Red and green light flashing alternately	Vertical calibration process
	Flashing blue light	No RC signal
	Solid blue light	RC and aircraft is not paired,GPS is located

	Solid red light	Serious error
	Double-flashing red light	Serious low battery level
	Flashing red light	Low battery level
	Blue and green light flashing alternately	Compass data error

2. Remote controller

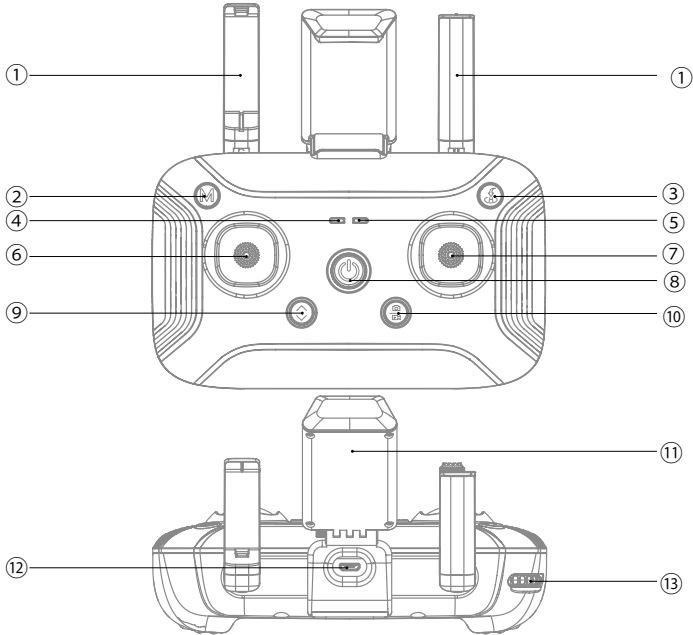

1) Console





- ① Antenna
- ② Flight Mode Switch
- ③ RTH
- ④ Mode Indicator Light
- ⑤ Power Indicator Light
- ⑥ Left Joystick
- ⑦ Right Joystick
- ⑧ Power
- ⑨ One Key Takeoff/Landing
- ⑩ Photo/Video
- ⑪ Mobile Device Holder
- ⑫ USB Port
- ⑬ Gimbal Adjustment



2) Power indicator light

Charging(Turn off the remote control before charging.)

Indicator Light	Status Indication
	Flashing green light
	Solid green light

In operation

Indicator Light	Sound	Status Indication
	Null	RC is working normally
	B-B- B-.....	Low battery warning, please charge RC immediately

 -----	Quickly flashing red light	B-B-B-.....	Serious low battery warning, RC will automatically turn off when the sound stops
 _____	Solid red light	Null	Serious error
 - - - - -	Double-flashing green light	BB-BB-BB-.....	If motionless for 5 minutes, operate the RC and the beep sounds will stop.

3) Mode indicator lights

Indicator Light		Sound	Status Indication
 _____	Solid green light	/	GPS mode
 - - - - -	Slowly flashing green light	B-B- B-.....	Altitude hold mode

3. About optical flow positioning system

Placed on the bottom of the aircraft, the optical flow positioning system senses the movements of the aircraft with the assistance of the camera, and calculates the current altitude, helping to precisely locate the aircraft's position.

When the aircraft is ready to take off, the optical flow positioning function cannot be activated due to the low altitude with the aircraft's front indicator light blinking slowly. After the aircraft has taken off and the conditions are satisfied, the optical flow positioning function will automatically turn on and locate the aircraft's position as to enable hovering with the aircraft's indicator light turning solid red.

Attention: In mid-flight, the optical flow positioning function cannot be activated if the aircraft's front indicator light turns slow blinking red. Please pay proper attention for a safe flight.

The optical flow positioning system is significantly affected by the intensity of the light and the surface texture of the physical object. If the optical flow positioning system fails to work, its function of horizontal centered absolute positioning will be ineffective. In this situation, please manually control the aircraft and pay proper attention whilst flying the aircraft in the following scenarios.

Usage Scenarios

- The optical flow positioning system is applicable for altitude between 0.5 and 4 meters and suitable for either indoor or outdoor windless environment.
 - The aircraft's indicator light turns slow blinking red when the system fails to locate position and turns solid red when the system functions properly.
 - Do not fly the aircraft if the app reminds you that the system is not able to function properly in the current environment (such as badly-lit environment).
 - Do not cover up the camera. Keep the camera clean and in good condition at all times.
 - The optical flow gives information about object movement within the environment based on moving object detection on the ground surface. Ensure the surrounding environment is brightly lit and rich in texture.
 - The optical flow positioning system may fail to work in such conditions as water bodies, badly-lit environment or poorly-textured surfaces.
- 1) The system may fail to locate position when the aircraft flies fast at a low altitude (0.5 meter below).
 - 2) The surfaces in pure colors (such as pure black, pure white, pure red, pure green).
 - 3) Highly reflective surfaces.
 - 4) Water bodies or the transparent surfaces.
 - 5) The surfaces of moving objects (such as the crowds, and bushes or brushwood with strong wind blowing).
 - 6) The environment where the light changes rapidly.
 - 7) Badly-lit (light intensity less than 300 lux) or brightly-lit (light intensity more than 10,000 lux) surfaces of the objects.
 - 8) Poorly-textured surfaces.
 - 9) The surfaces that have been featured with highly-repeated textures (such as same-colored checker bricks).

10) Tiny barriers.

11) Control the aircraft to fly at an appropriate speed of about 5m/s at the altitude of 1 meter.

4. Download APP

Please connect the APP before using this product. It is able to use the APP to manipulate the flight and the gimbal and the camera, and control functions such as taking photos or videos and other settings.

Scan the following QR code to download APP



Google Play



APP Store

Notice: For more details on how to control the aircraft via the APP, please refer to "Fly via the APP" in this manual. When using the APP, users need to make sure that mobile phone supports 5G Wi-Fi, otherwise the aircraft is unable to connect with the phone.



VII. Preparation before flight

1. Battery charging for aircraft

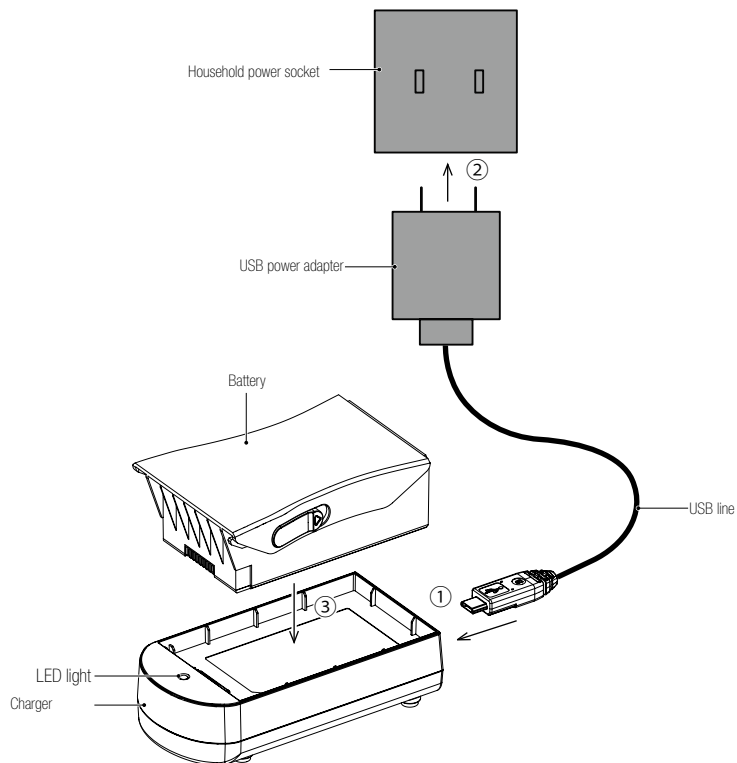
- (1) Connect USB adapter with the aircraft battery.
- (2) Connect the power cord with the charger at one end and plug in the socket at the other end.
- (3) Insert the aircraft battery into the charger with the battery line well connected.



○ Charger status

-  Green light flashing (Charging)
-  Green light turns solid (Charging completed)

Warning: In order to avoid possible damage and loss, it is important to use specific battery and charger.

Please charge in a well ventilated environment and ensure that the charging device is far away from the heat source.

When charging, please place the battery and charger on the non-flammable and combustible ground (such as cement ground).

Please pay attention to the charging process to avoid accidents.

2. Remote controller preparation (If using the APP, please skip this step)

1) Before flying, please follow these steps to get the remote controller ready for flight

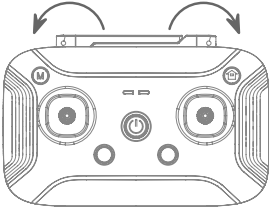

a. Expand the antenna to each side.

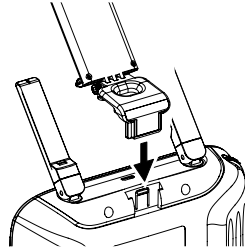

b. Insert the bracket into the slot on the back of the remote controller.

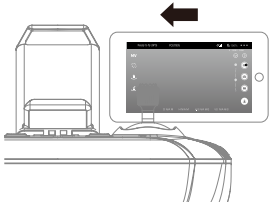

c. Mount the phone to the phone holder.

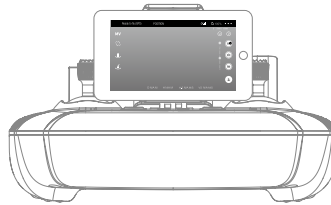

d. Adjust the phone and antenna until the phone is fixedly mounted.

2) Battery charging for remote controller

Long press power button on remote controller to turn on the remote controller. The indicator light turns solid green when the battery level is high, and turns flashing green when the battery level is low. When at a low battery level, please recharge the battery in compliance with the following steps:

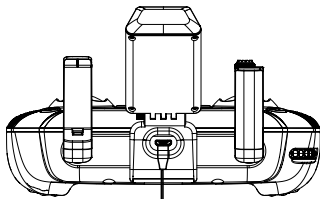

USB charging cable

USB adapter



Household power socket

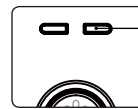

Indicator Light

☀ Green light flashing (charging)

● Green light turns solid (charging completed)

Warning: Disconnect the charging cable while using the remote controller.

3. Preparing the drone

- 1) Unfold the crankshafts outward, as shown in the picture in the left bottom corner ;

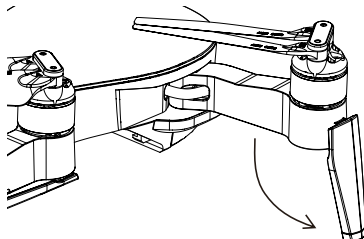
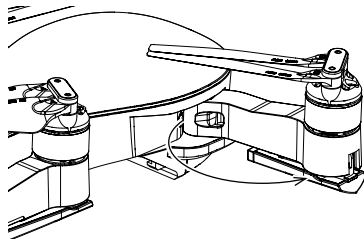

- 2) Unfold the undercarriage outward, as shown in the picture in the right upper corner ;

- 3) Unfold the propellers outward, as shown in the picture below ;

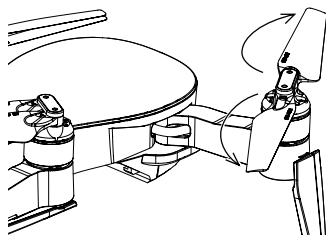

- 4) Unfold the other three crankshafts, undercarriages and propellers respectively, as shown in the picture in the left bottom corner :

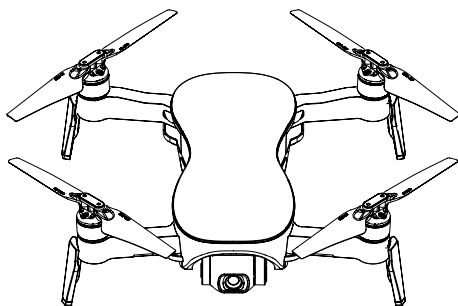

4. Insert TF card

The TF card slot is positioned at the bottom area of the casing.

To insert the TF card, please open the TF slot, as shown in the right picture, and insert the TF card along the direction as indicated in the picture. Ensure the TF card has been well inserted before refitting the compartment cover.

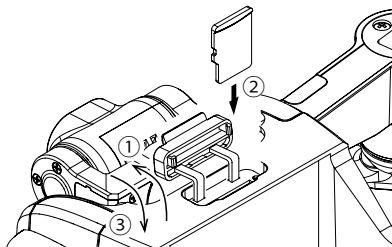

Caution: Do not install or remove the TF card when aircraft is powered on, otherwise, the data storage will be affected.

5. Battery installation

1) Install

Insert the battery into the battery compartment, as shown in the picture in the left bottom corner, and press the bottom of the battery until fixed. To check if the battery lock catch has been fastened, please refer to the picture in the right bottom corner.

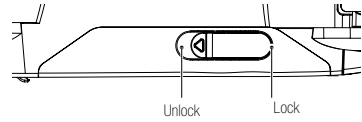
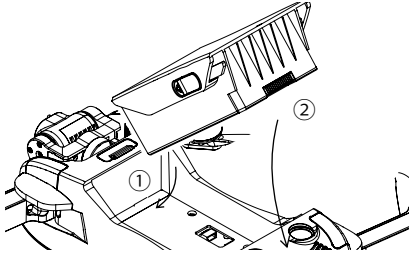

2) Take out

Push the lock catches on the two sides of the battery upward to its utmost as to unlock the battery, as shown in the right picture. And pull upward to take out the battery from the compartment..

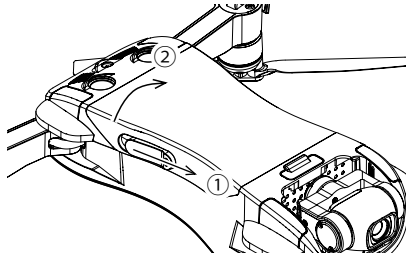

VIII. Fly with the remote controller

1. Power on

1) Put the aircraft on the flat surface

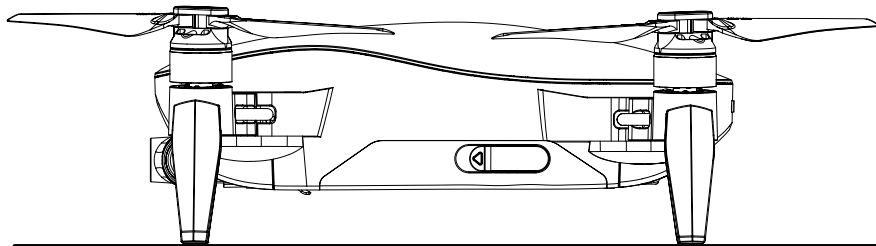

2) Turn on aircraft

Long press the power button for 2 seconds.

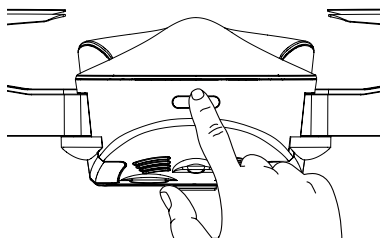

3) Self-inspection and pairing

Power on the aircraft on flat ground for about 30 seconds for self-inspection. When the aircraft's indicator light turns from flashing or solid blue to flashing green or solid, the aircraft has successfully paired with the remote controller.

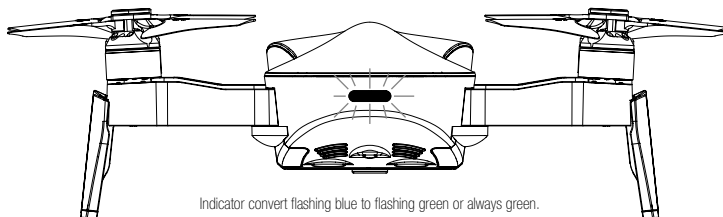

Indicator convert flashing blue to flashing green or always green.

2. Connect with the APP

1) GPS signal status with the aircraft connected with the APP

When the APP is connected to the aircraft and the indicator light of the aircraft turns solid green, indicating the GPS is located successfully, switch flight mode to GPS mode to get ready for takeoff.

When the APP is connected to the aircraft and the indicator light of the aircraft turns flashing green, indicating GPS signal strength is weak or no signal, switch flight mode to altitude hold mode to get ready for takeoff. It requires experienced skills for operation when in altitude hold mode.

Notice: Set the drone up and get ready to take off after the aircraft's indicator light turns solid green (indicating good GPS signal strength).

Please choose an open and spacious field. Tall steel structures and metal materials will interfere the compass and GPS.

2) Connect with the APP

Open the APP, click WLAN setting, and click "Controller-XXXXXX".

Open the APP, enter the main interface shown in the left image below, click the "Start Flying" on the interface to enter the interface as shown in the right picture:

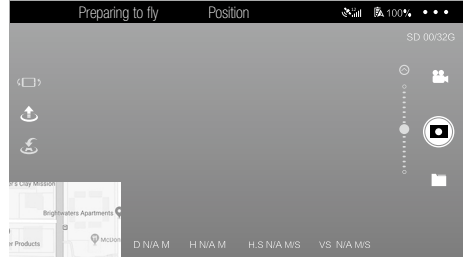
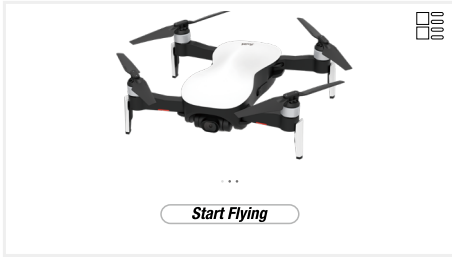
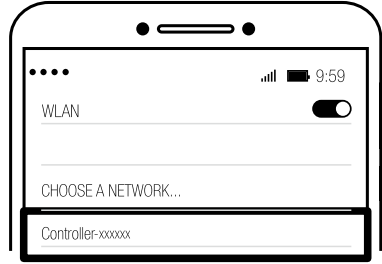

Notice: The aircraft can only connect to 5G Wi-Fi enabled mobile phone.
 Use APP to monitor the real-time footages and the current state of the aircraft.
 It is able to use both of the remote controller and the APP to control the aircraft. However, some functions are not supported on the APP when the controller being used, such as taking photos or videos, follow me mode, point of interest mode or waypoint flying mode. The APP can only be used when the remote controller turns off. For more details, please refer to the "Fly with the APP" below in this manual..

3. Operate the aircraft

1) Takeoff

○ Method 1: take off manually

When the aircraft's light turns from blue to green (shown as the right picture), toggle the left and right joysticks outward for at least 3 seconds (shown as the picture) as to get the propellers started to rotate.

Slowly toggle the throttle joystick upward to control the aircraft to take off quickly, and then toggle again to make it ascend slowly.

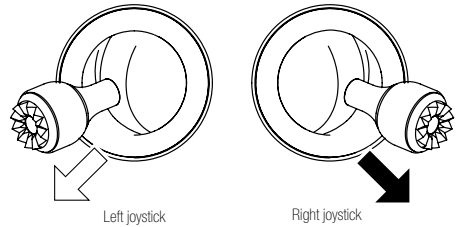

○ Method 2: one key takeoff

Long press the "One Key Takeoff/ Landing" button for 2 to 3 seconds. When the remote controller beeps steadily, the aircraft will automatically take off and ascend to the altitude of 1.2 meters and hover.

2) Landing

Please be aware of the crowds or obstacles and ensure the aircraft is hovering over the landing site before landing. Choose an open and flat space as your landing site.

○ Method 1: land manually

Slowly toggle the throttle joystick to control the aircraft to land. When the drone lands on the ground, continue to toggle the joystick towards the lowest position until the propellers stop rotating.

○ Method 2: one key landing

Long press the "One Key Takeoff/ Landing" button for 2 to 3 seconds. When the remote controller beeps steadily, the aircraft will land vertically.

3) Remote controller joystick instruction

(1) Mode 2

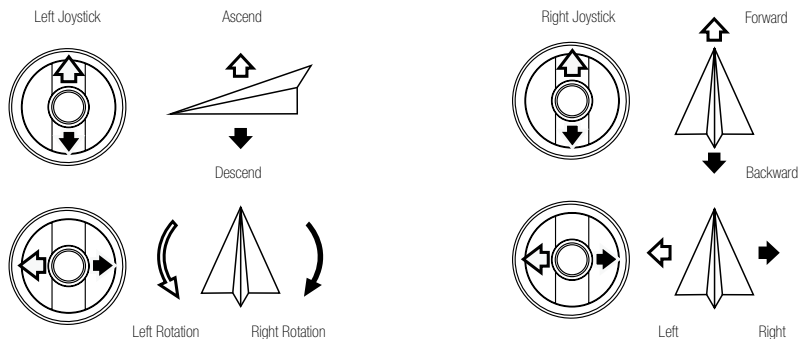

(2) Mode 1

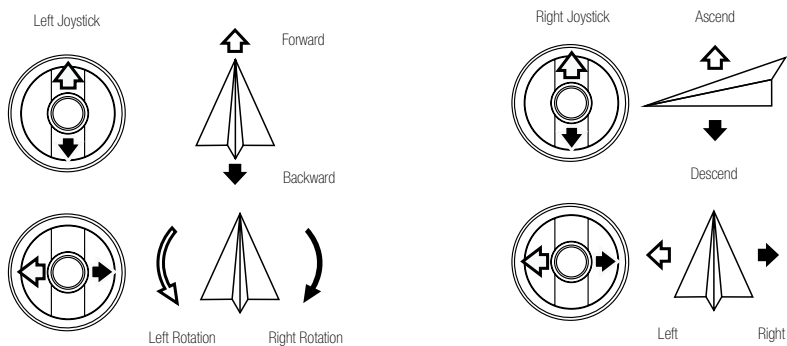

4) Switch to mode 1 or mode 2

(1) Switch to mode 2

Toggle the left joystick ① to the lowest position and press the "One Key Takeoff/ Landing" button ② at the same time. Then turn on the remote controller ③. Release the joystick ① and the button ② to enter Mode 2.

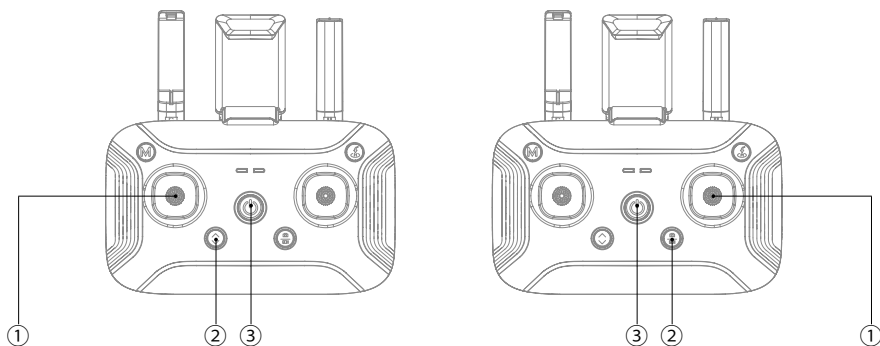

(2) Switch to mode 1

Toggle the right joystick ① to the lowest position and press the "Photo/ Video" button ② at the same time. Then turn on the remote controller ③. Release the joystick ① and the button ② to enter Mode 1.

4. Photo and video

1) Take photos and videos with the remote control

During the flight, you can take photos and videos of the current scene through the "Photo/Camera button" on the remote control.

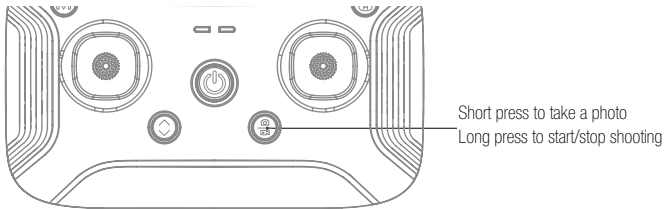

Short press "📷/📹" Photo/Camera button, the remote control will give "B" sound, indicating that the camera is successful.

Press and hold the "📷/📹" Photo/Camera button, the remote control will give "B" and "B" sound, and the camera icon on the APP will change from white to red, indicating that it has entered the camera mode. Press and hold the "📷/📹" Photo/Camera button again, the remote control will give "B" and "B" sound, and the camera icon on the APP will change from red to white, indicating that the camera has stopped.

2) Use gestures to take photos and videos

The drone is featured with gesture recognition. To activate it, open App and turn on "Gesture Recognition". In mid-flight, you can use the following gestures in front of the drone camera to take photos or videos.



(1) Victory Gesture

Keep 2 meters from the drone and face the drone camera, raise one of your hands in front of you and make a V shape. When your gesture has been successfully recognized, it will automatically set a three second countdown before taking pictures.



(2) Square Gesture

Keep 2 meters from the drone and face the drone camera, make square gestures for shooting around your chin. When your gesture has been successfully recognized, it will automatically start filming. When it recognizes your gesture for the second time, it will automatically finish filming (The interval between the first and second time for recognition should be at least 3 seconds).



(3) Palm Gesture

Keep 2 meters from the drone and face the drone camera, close your hand firmly and raise it in front of you. When your gesture has been successfully recognized, it will automatically start filming. When it recognizes your gesture for the second time, it will automatically finish filming (The interval between the first and second time for recognition should be at least 3 seconds).

Note: To ensure a high recognition rate, please note that:

- 1. Face the drone camera;**
- 2. Fly the drone in well-lit environment;**
- 3. Use gestures when you stay around 2 meters away from the drone camera.**

It has a lower recognition rate when:

- 1. In badly-lit or backlighting environment;**
- 2. Weak Wi-Fi signal or signal has been interfered.**

○ Aerial photography tips

- (1) Check the condition of all parts before flight.

- (2) Take photos or vides when the drone is in position hold mode.
- (3) Shoot on sunny and breezy days.
- (4) Slightly toggle the joystick in mid-flight as to ensure a smooth flight.

Note: In order to avoid possible damage or loss, please ensure that the camera is free to rotate. High temperature may cause damage to the camera and even cause injury.

5. Adjustment of the camera's pitch angle

Tilt the camera upward or downward as to achieve the best shooting angle and capture the perfect images or footages when taking photos or videos.

Scroll the scroll button on the top left corner of the remote controller as to control the pitch angle, as shown below.

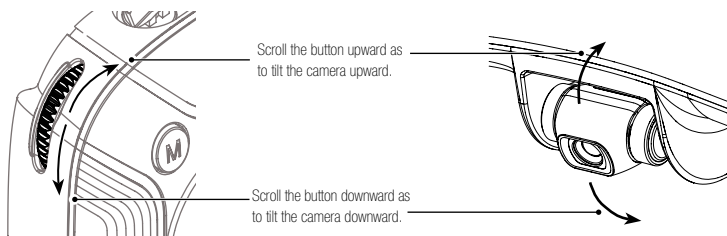

6. Flight mode

1) Position hold mode

○ How to enter position hold mode

- a. Default flight mode is GPS mode.
- b. When the drone is in altitude hold mode and the GPS positioning system is working well, long press the button on the remote controller to switch to position hold mode.

○ Indicator light status of the aircraft and the remote controller

The left indicator light on the controller turns solid green.

○ Notice

In position hold mode, the aircraft will automatically locate its position and hover steadily. Please choose an open and wide outdoor field before flight, and wait until the GPS has been turned on before flying it.

2) Altitude hold mode

○ How to enter altitude hold mode

When aircraft is in position hold mode, long press mode switch button to switch to altitude hold mode.

○ Indicator light status of the aircraft and the remote controller

The left indicator light on the controller turns solid red.

○ Notice

The aircraft in altitude hold mode requires pilots with experienced operation skills. However, certain environmental factors, such as airflow, might affect the flight, resulting in drifting or hovering failure.

Please familiarize with the position hold mode and learn how to handle it before using altitude hold.

Note: As for the return to home point as precise as possible, please fly the aircraft in open flat terrain (no tall buildings in 50 meters of radius, flat terrain in 10 meters of radius) with the GPS working well. Thus the return to home function will be able to activate.

7. Return to home

In GPS positioning mode, you can press the "One Key Return" button to return the aircraft. Do not control any functions during the process of return or ascent. When the aircraft is landing, you can toggle the joystick as to control it to land on your desired location. When the aircraft is returning to home point, long press the "Return" button to exit auto return mode.

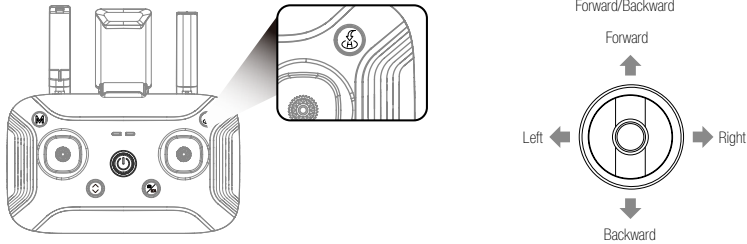

Note: As for the return to home point as precise as possible, please ensure the GPS positioning function has been turned on to record the aircraft's position before its takeoff and choose an area with no obstacles. With the GPS positioning mode turned on, it will automatically enter auto return to home mode if the remote controller loses control.

Once the auto return to home mode is enabled, if the aircraft flies below 30 meters of altitude, the aircraft will automatically ascend to 30 meters before returning to home point. However, if the aircraft flies over 30 meters of altitude, the aircraft will return to home point at the current altitude. Please do not control other functions during the process of return. Please ensure there are no obstacles in way of return in case of any potential accidents.

After the aircraft lands and the propellers stop rotating, long press the power switch for over 2 seconds to turn off the aircraft and the remote controller.

Caution: Please stay away from aircraft until 8 propellers stop rotating completely.

8. Remove the battery and store it separately

- (1) When finishing flight, please remove the batteries from the aircraft and remote controller and store them separately.
- (2) Keep batteries out of the reach of children. Keep the battery dry. DO NOT leave the battery near heat sources such as a furnace or heater. The ideal storage temperature is 22 C -28 C.
- (3) If a battery is found to be damaged, please discharge the battery and dispose them properly according to the local regulations and laws.

9. Pair aircraft and RC

The aircraft has already paired with the remote controller by default. If the remote controller has been replaced with a new one, please pair again complying with the following steps:

- (1) Power on the aircraft and the remote controller;
- (2) Open your mobile phone, enter the menu of "Settings-> WLAN" and check the list of available Wi-Fi networks. Find the networks for the aircraft "Drone-xxxxx" and the remote controller "Controller-xxxxx" and take down the serial number of the remote controller for future reference;
- (3) Choose the Wi-Fi network for the drone and connect to it;
- (4) Enter the APP interface and click "... " in the upper right corner to enter the setting menu;
- (5) Click "Pair";
- (6) Type the serial number of the remote controller in the pop-up box and click "Pair" to confirm;
- (7) Enter the menu of "Settings-> WLAN" and check if the aircraft's serial number and the remote controller's serial number are the same. If so, the pairing has been completed with the indication that the aircraft's rear light turns from blinking green to solid light.

IX. Flying with the APP

1. Power on

- (1) Insert the battery into the battery compartment.
- (2) Put the aircraft on the flat surface and long press the power button for 2 seconds to switch on the aircraft.

Power on the aircraft and put the aircraft on flat ground for over 30 seconds for self-inspection. When the aircraft's indicator light turns flashing blue, the aircraft has completed self-inspection.

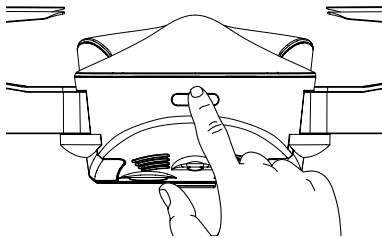

2. Connect with the APP

- (1) Open the APP, click WLAN setting and click "Drone-xxxxx" to connect.
- (2) Please click to learn how to operate the aircraft before flight. Click "start flying" to enter flight interface shown as in the picture below:

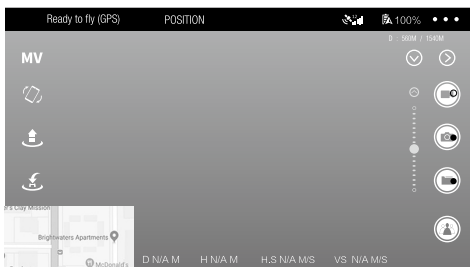
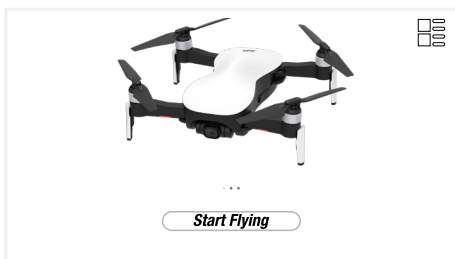

Notice: The aircraft can only connect to 5G Wi-Fi enabled mobile phone.

3. Initiate aircraft

1) Select control mode

The default control mode is mode 2. Enter the "General Setting" on the APP to switch the control mode.

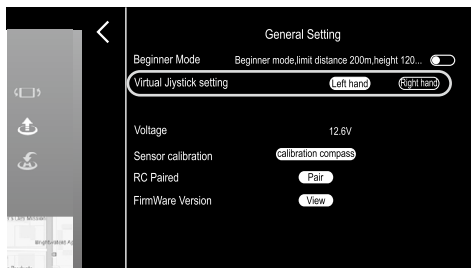

2) Position hold mode by default

The aircraft's indicator light turns solid green or blue, indicating good GPS signal and the aircraft already located.

The aircraft's indicator light turns flashing green or blue, indicating the aircraft not located yet.

The flight mode on the APP is position hold mode by default.

When the aircraft's indicator light turns solid green, indicating good GPS signal and the aircraft located, you can control it to take off.

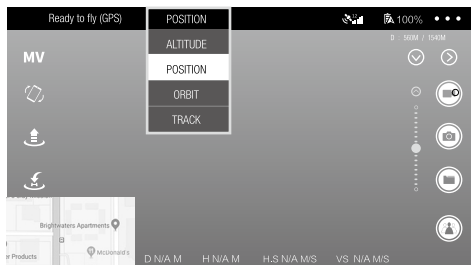

Notice: For novice pilot, please use the position hold mode for your first flight, and switch to other control mode after you have familiarized with the operation. Please check the control mode before takeoff.

3) Takeoff(please stay away from the aircraft during its takeoff)

Click the blank area of the screen, and the virtual joystick will pop up on the screen. Toggle the left and right joysticks outward (shown as the picture) to unlock the aircraft and get the propellers to start rotating.

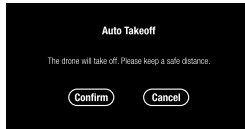

One key takeoff: Click  and it will pop up with a confirmation box on the screen.

Click "OK". And the propellers will speed up its rotation to make the aircraft take off. Please stay away from the aircraft during its takeoff.

Click  and it will pop up with a confirmation box on the screen. Click "OK". And the propellers will automatically start to land. Please stay away from the aircraft during its landing.

4) Toggle the left and right joysticks to control its direction after takeoff

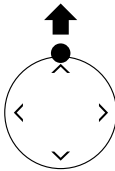

Takeoff:
Slowly push the throttle up to control the aircraft to take off.

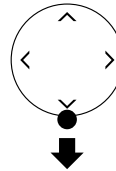

Landing:
Slowly toggle the throttle joystick downward to control the aircraft to land on the ground. Then continue to toggle it to the lowest position until the propellers stop rotating.

Please refer to the following illustrations in mid-flight.

(1) Mode 2

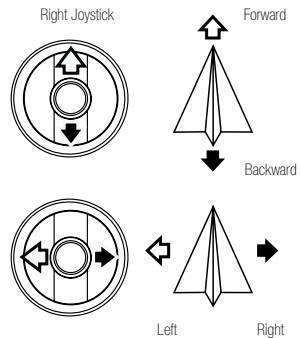
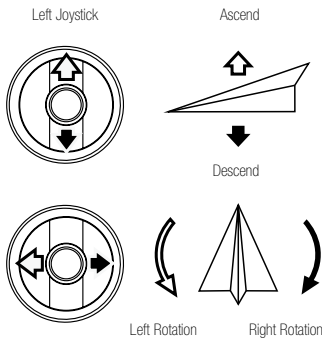

(2) Mode 1

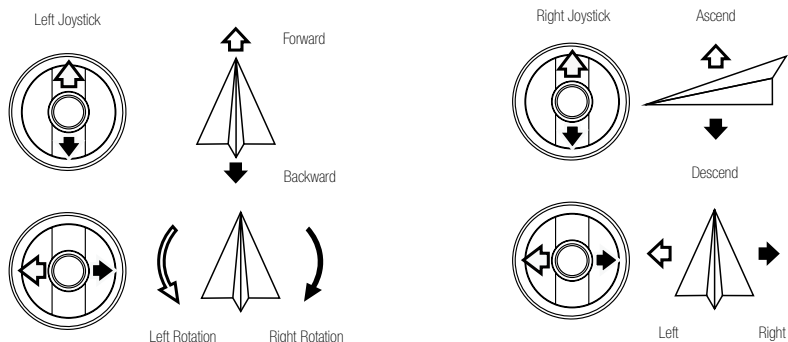

5) Gravity sensor control

Click to initiate gravity sensor control mode, in which you can control aircraft to fly forward, backward, turn left, or right through shaking the phone. Click again to turn off this mode. This function can only work with the assistance of the phone. Please be aware and use it carefully.

Warning: Please keep the phone balance. The phone must support G-sensor.

4. Photo and video

1) Take photos and videos with the app

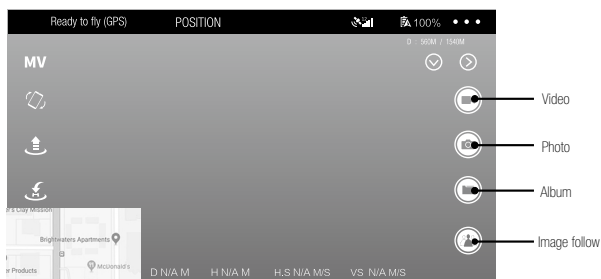

During the flight, click the " "Photo" / " "Camera" button to take image or video footages. Click the " "Photo" button to save a photo in the album.

Long press the " "Camera" button and wait until the APP icon turns red, indicating it has been ready for video shooting. Long press the button again and wait until the APP icon turns white, indicating it has stopped recording. All the videos will be saved in the album.

2) Use gestures to take photos and videos

The drone is featured with gesture recognition. To activate it, open App and turn on "Gesture Recognition". In mid-flight, you can use the following gestures in front of the drone camera to take photos or videos.



(1) Victory Gesture

Keep 2 meters from the drone and face the drone camera, raise one of your hands in front of you and make a V shape. When your gesture has been successfully recognized, it will automatically set a three second countdown before taking pictures.



(2) Square Gesture

Keep 2 meters from the drone and face the drone camera, make square gestures for shooting around your chin. When your gesture has been successfully recognized, it will automatically start filming. When it recognizes your gesture for the second time, it will automatically finish filming (The interval between the first and second time for recognition should be at least 3 seconds).



(3) Palm Gesture

Keep 2 meters from the drone and face the drone camera, close your hand firmly and raise it in front of you. When your gesture has been successfully recognized, it will automatically start filming. When it recognizes your gesture for the second time, it will automatically finish filming (The interval between the first and second time for recognition should be at least 3 seconds).

Note: To ensure a high recognition rate, please note that:

- 1. Face the drone camera;**
- 2. Fly the drone in well-lit environment;**
- 3. Use gestures when you stay around 2 meters away from the drone camera.**

It has a lower recognition rate when:

- 1. In badly-lit or backlighting environment;**
- 2. Weak Wi-Fi signal or signal has been interfered.**

○ Aerial photography tips

- (3). Check the condition of all parts before flight.**
- (4). Take photos or vides when the drone is in position hold mode.**
- (5). Shoot on sunny and breezy days.**
- (6). Slightly toggle the joystick in mid-flight as to ensure a smooth flight.**

Note: In order to avoid possible damage or loss, please ensure that the camera is free to rotate. High temperature may cause damage to the camera and even cause injury.

5. Adjustment of the camera's pitch angle

Tilt the camera upward or downward as to achieve the best shooting angle and capture the perfect images or footages when taking photos or videos.

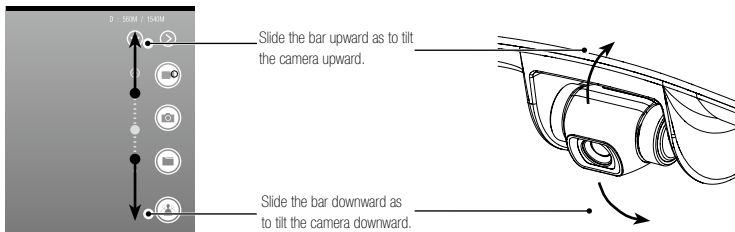

Slide the scroll bar on the right side of the app as to control the pitch angle, as shown above.

6. Flight mode

1) Position hold mode

User can choose position hold mode when GPS signal is good (the aircraft's indicator light turns solid green). In this mode, the aircraft will automatically locate its own position and perform a stable flight.

2) Point of interest

In point of interest mode, the aircraft will circle around a definite subject. You can control it forward or backward or change its radius.

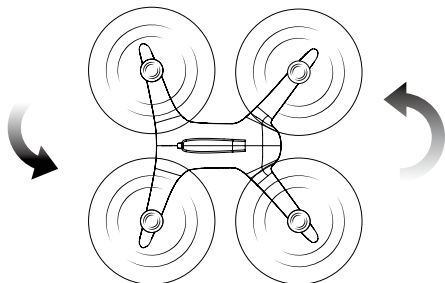

Click "point of interest" and the aircraft will start circling around a definite subject.

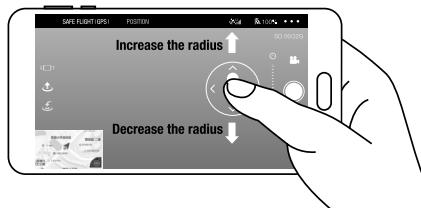

Toggle the right joystick to increase or decrease the circling radius (shown as the above picture in mode 2).

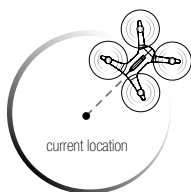

When the radius has been changed, the aircraft will circle around the point when the point of interest mode turned on.

3) Altitude hold mode

Only optical flow positioning function is supported in this mode, which requires experienced operation skills. In mid-flight, if the optical flow positioning fails to locate the position (with the aircraft's front indicator light flashes), please manually control the aircraft. Please familiarize with the position hold mode before using the altitude hold mode.

4) Follow me(under 'Safe GPS flight' status)

Select the follow me mode in mid-flight, and the aircraft will automatically follow your mobile device.

- (1) Please pay attention on GPS signal strength in follow me mode

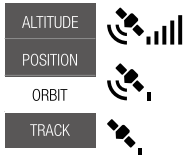

Turn on the follow me mode with full GPS signal.

Do not turn on the follow me mode with good but not full GPS signal.

Once turned on, please be aware of the aircraft and the surroundings at all times.

Do not turn on the follow me mode with weak GPS signal.

- (2) How to use follow me mode

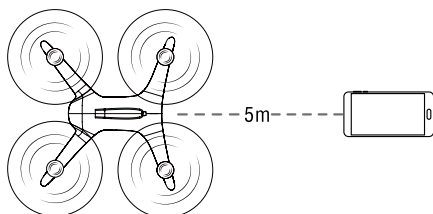

The aircraft will follow the mobile phone with 5 meters in distance.

Warning: As for the return to home point as precise as possible, please fly the aircraft in open flat terrain (no tall

buildings in 50 meters of radius, flat terrain in 10 meters of radius) with the GPS working well. Thus the return to home function will be able to activate.

5) Auto follow

In altitude hold mode with the optical flow positioning module running (between the altitude of 0.3 to 3 meters), click on the icon on the App, and the Portrait Follow and Gesture Follow mode will pop up.

(1) Portrait Follow

In Portrait Follow mode, a blue box will pop up on the screen, which you can use your fingers to select your target, as shown in the left corner picture.

When the target is set and the box turns from blue to red, control the drone to fly within the red box, as shown in right upper picture. When the drone is 2 meters away from the target person, it will automatically activate auto follow mode. Once the target is missing, please select a new one.

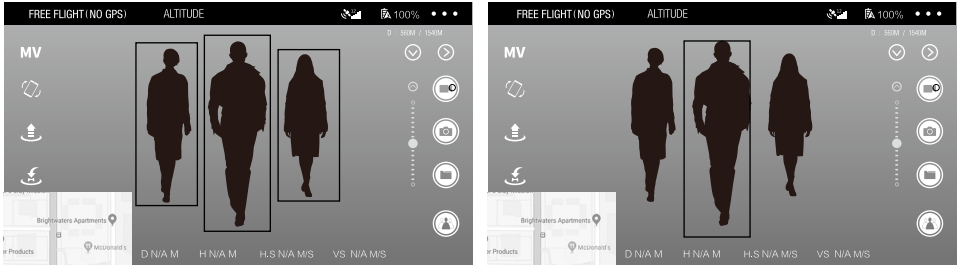

(2) Gesture Follow

Face the drone camera and raise up one hand. When your finger has been identified in the red box, slowly move your palm to let the drone follow its movement.

When the drone is 2 meters away from the target person, it will automatically activate auto follow mode. Once the target is missing, please select a new one.

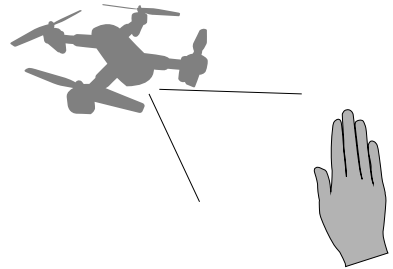

7. Return to home

Turn on the auto return to home function in mid-flight. When the confirmation box pops up, click "Confirm" to enter return to home mode. And the takeoff point will be the home point to return. The joysticks can not be used during the process of ascent and return. During its landing, you can toggle the joystick to control the aircraft and decide the landing site. During its return, press the "Return" button again to exit auto return to home mode.

Press the "Return" button again to exit auto return to home mode and control other functions.



RTH button

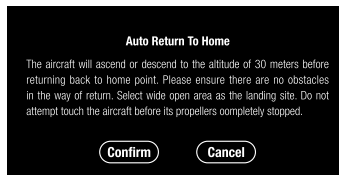

Confirmation box

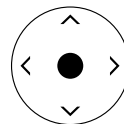

Forward/Backward

Notice: With the GPS positioning mode turned on (the aircraft's rear light turns solid), control the aircraft to take off in the area where there are no obstacles around as for precise home point. When aircraft under GPS mode, it will automatically initiate the RTH as follows:

- 1) the aircraft disconnects with the RC
- 2) low battery level of aircraft

Once the auto return to home mode is enabled, if the aircraft flies below 30 meters of altitude, the aircraft will automatically ascend to 30 meters before returning to home point. However, if the aircraft flies over 30 meters of altitude, the aircraft will return to home point at the current altitude. Please do not control other functions during the process of return. Please ensure there are no obstacles in way of return in case of any potential accidents.



After the aircraft lands and the propellers stop rotating, long press the power switch for at least 2 seconds to turn off the aircraft and the remote controller.

8. Waypoint flying

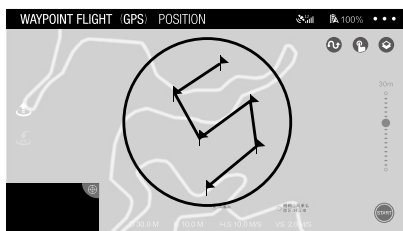
Click the map on the left corner at APP, it will pop up map/Way point flying.



Set course point

Ensure high battery level of the aircraft and the mobile phone before enabling the waypoint flying mode. Click  "Way point Flying" or  "Flight Planning" after its takeoff and read through the attention tips. Tap way-points on the screen and set the altitude (30 meters of altitude by default) on the right side of the screen. Then click  "Start" to enable waypoint flying mode. You will see the aircraft fly towards the designated point.

Click  "Stop" to exit waypoint flying mode. When the aircraft flies towards the final waypoint, it will hover at that point.

30m



Set altitude (default altitude is 30m)



Click start



Read the attention tips and confirm

Caution: Please tap the waypoints within the circle (in radius of 100 meters). When the waypoint flying mode has been turned off, the aircraft will hover. To restart, you can tap other waypoints and turn on this mode again. During its return of landing, the aircraft will automatically exit waypoint flying mode and return to home point or land on the ground.

Warning: For your personal and property safety, please use this function cautiously. Always choose open and spacious outdoor filed, away from crowds, to fly the aircraft. Also pay attention to the flight environment and flight altitude.

X. MV filming

Navigate to the main control interface of the App, click "MV Filming" icon to enter the control interface and get ready for MV filming.



Image Rotation

Click on the icon to turn on the image rotation function.

Slide your finger on the screen to rotate the image. Double click on the screen to zoom the image (This operation is also applicable for recording).

JJRC Technical Support

Dear Customer,

Thank you for choosing JJRC product. Please visit JJRC official website for more FAQ and information if there is any problem of using our product.

Product Operation: Please visit JJRC College for tutorial video or user manual.

Product Features: Please refer to product page description or product brochure.

After-sale Service: Please refer to conditions and terms of after-sale service. The final interpretation right belongs to all JJRC.

Should you have any further questions, please visit JJRC Online Feedback and leave your message.

Thank you again for your support!

JIANJIAN TECHNOLOGY CO.,LTD.

www.jjrc.com